



Aluminium Window & Door Systems



REVOLUTION
TRADE FRAMES

SUPPLIERS & INSTALLERS

TO THE TRADE & PUBLIC



Contents

BY EXPERTS	5
WHY CHOOSE ALUMINIUM?	6
A SYSTEM FOR EVERY APPLICATION	8
TRIED, TESTED AND TRUSTED	11
WINDOW SYSTEMS	12
FUNCTIONALITY AND FLEXIBILITY	14
58BW FLUSH	16
CASE STUDY	18
58BW CASEMENT	20
58BW ST HERITAGE	22
CASE STUDY	24
58BW TILT BEFORE TURN	26
TOP SWING REVERSABLE	28
C70S COMMERCIAL	30
DOOR SYSTEMS	32
58BD ENTRANCE	34
58BD FLUSH ENTRANCE	36
GT55 TB COMMERCIAL DOOR	38
GT55 NI COMMERCIAL DOOR	40
INFINIUM SLIDING	42
SCI56 LIFT AND SLIDE	44
BSC94 LIFT AND SLIDE	46
BSC94 IN-LINE SLIDING	48
F82 BI-FOLD	50
BSF70 BI-FOLD	52
CASE STUDY	54



By experts for experts

It's fair to say we live and breathe aluminium at AluK. From its melting point of 660.32°C, its vital role in the aerospace industry, to its remarkable low density, there's little we don't know about atomic number 13. More importantly, we're experts at using this versatile metal to create high performance and sustainable window and door systems that surpass the needs of fabricators and installers across the UK.

From the production line to our design and sales offices, every member of the AluK team is a leader in their field. It's this collective expertise and our traditional family values that has enabled us to design, engineer and manufacture industry-leading facade systems since 1993; that's over 25 years of experience.

Boasting slimmer sightlines and greater feature options, all our products are manufactured to the highest UK standards. So whether commercial or residential, modern or traditional, you can be confident our experts will ensure every AluK product delivers peerless performance and signature style.

AT ALUK WE BELIEVE
COLLABORATION IS KING. IT'S
WHY WE'RE PROUD OF THE
PARTNERSHIPS WE'VE BUILT
WITH FABRICATORS, INSTALLERS
AND ARCHITECTS THROUGHOUT
THE UK AND BEYOND



Justin Hunter
AluK Managing Director

Why choose AluK aluminium systems?

For over 25 years, we've been at the forefront of aluminium window and door design.

But why aluminium?

- › It's lightweight, strong and almost 100% recyclable
- › It doesn't warp or rust and is near maintenance-free
- › Plus it's exceptionally versatile and easy to install

Driven by design

Without compromising on strength, our aluminium window and door systems are designed to offer your customers the narrowest of sightlines, allowing bigger glazing and providing greater light into their home.

Our integrated systems are designed for maximising profiles and parts, as well as to ensure fast fabrication and a wide range of installation options.

Colour

Access a large spectrum of contemporary and classic colour choices and finishes.

We also offer a range of standard single and dual colour products from stock with our core offer.

For full core offer details email info.uk@aluk.com

Security

We understand the importance of security to your customers. That's why all our window and door systems are independently tested to ensure they not only meet current security regulations for new builds, but that they're inherently burglar resistant too.

Most of our systems are also certified by PAS 24, Secured by Design and Q-marked accredited.

Thermal efficiency

Our window and door systems offer award-winning U-value performance for both double and triple glazing.

In fact, we were the first company to ever gain an A-rated aluminium double glazed window system in the market.

Performance

Each system includes water and acoustic barriers, and utilises the latest manufacturing technologies and techniques to provide long-term peace of mind.

They also have integrated drainage paths that allow water to pass through the system. This, combined with the high quality air seals and barriers, ensures they can tackle the everchanging British climate with ease.

Window Energy Ratings

Our aluminium window systems are rated for their energy efficiency using the familiar A-G scale.

This means homeowners and architects can instantly see which windows to choose. WERs also affect fabricators, because in order to supply WER products a fabricator must join an official and recognised scheme.

This is to ensure that manufacturers can prove they have audited processes in place and that the ratings displayed are accurate.

As you'd expect, we have our own group scheme at AluK. This provides members fast track access to all our WER data, saving them valuable time and effort.



Service excellence

Expert service is key at AluK, so our trained architectural technicians and engineers are always on hand to offer guidance and support from design through to installation. We also have highly experienced Project Consultants able to help with design, system selection, construction details and project specifications for your specific sector.

AluK Academy

Training is another key service we provide. From CPDs and toolbox talks to hands-on guidance at our Academy Centre, we provide a wide range of training options to all our customers.

To find out more simply email training.uk@aluk.com

An AluK system for every application

If there's one thing homeowners, architects, installers and fabricators all have in common, it's the desire for choice. That's why we've created our wide range of aluminium façade systems, which meets the needs of different applications, performance and aesthetic demands.

To make life easy for homeowners, we've created three product ranges based on their individual requirements.

- ▶ For those looking for the thinnest sightlines and finest finish, there's our premium Infinium sliding door.
- ▶ If outstanding quality and standout at a competitive price is desired, the Luminia range is the obvious choice.
- ▶ While stylish design and everyday practicality is provided by the Optio range.

From a fabricator and installer perspective, we offer systems that cover everything from heavy duty and light commercial new builds, to large-scale refurbishment projects and residential new builds.

Whatever choice you make, you can be confident that our systems offer the superior performance and quality of aluminium through and through.



Multi-Residential



Light commercial



Commercial





Tried, tested and trusted

From trusted favourites to the latest innovations, our comprehensive range of aluminium window and door systems has been designed and developed with fabricators, installers and homeowners in mind at every stage.

Furthermore, every system delivers the aesthetic appeal and exceptional build quality demanded by the industry. It also goes without saying they've all been tested and certified to the latest standards and accreditations.

These include PAS 24, BS4873, Secured By Design and Qualicoat for starters. Not to mention ISO 9001. They also hold Q-Mark Certifications for general performance windows and enhanced security windows and doors. Should we go on?

Whichever system you choose, we'll work closely with you to ensure you have all the information you require for successful fabrication and installation.

All the latest structural, thermal and wind calculations are available, as is a comprehensive suite of CAD, NBS Specifications, performance and environmental data.

ALWAYS UP TO THE TEST



Window systems

For over two decades we've been designing unique aluminium window systems that exceed the performance standards expected in modern building design.

Manufactured to the highest standards, our systems are available in depths of 58mm, 70mm and 77mm, with a wide choice of colours and finishes customers desire, with the performance, quality and flexibility the trade demands.

An extensive range of complementary fittings are also available to ensure every design, whether commercial or residential, is exceptional.

We understand reputations are everything, so it goes without saying that all our aluminium window systems are rigorously tested and meet the most stringent security standards.

They also meet the Secured by Design standard issued by the UK Association of Chief Police Officers, and are BRE A-rated on the green guide.



Functionality and flexibility

We offer a wide range of window frame options that cater for various applications such as interface depths or bay angles.

We also understand that the ability to combine frame options is a major benefit to both the cost and appearance.

Our frame options include deep head profiles for trickle vents, odd leg frames for accommodating hardware timber and heritage for overcoming stone mullion and cill details.

Equal leg frame options are available from 25mm, 35mm and 55mm options.

Frame extenders are also available for our 70mm systems and for improved U-values.

Glazing options

Every project is different, which is why our systems allow for both internal and external glazing options.

We also offer glazing add-ons to suit heritage style applications.

Aesthetics

We offer a wide range of internal and external aesthetic styles. Chamfered, Ovolo, Square or Putty line options can really make any project look modern or traditional.

Our double beaded options allow for internal glazing without the use of dummy vents.

Openings

AluK windows are available in a full range of opening options; from open in to open out, side hung, top hung, bottom hung and tilt before turn, to French casement, fixed light and multi-light.

Design features

- › From odd leg and equal leg to deep head and frame reversers
- › Internal and external glazing options
- › PAS 24 certified
- › Integrated systems for maximising profiles and parts
- › Three chamber profile for maximising strength while crimping - achieves perfect corner assembly every time



Multiple glazing options

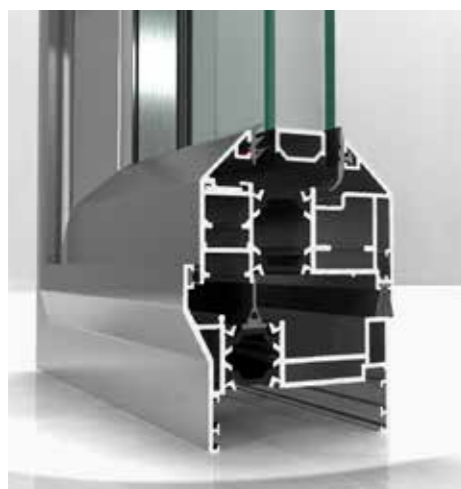

A wide range of aesthetics

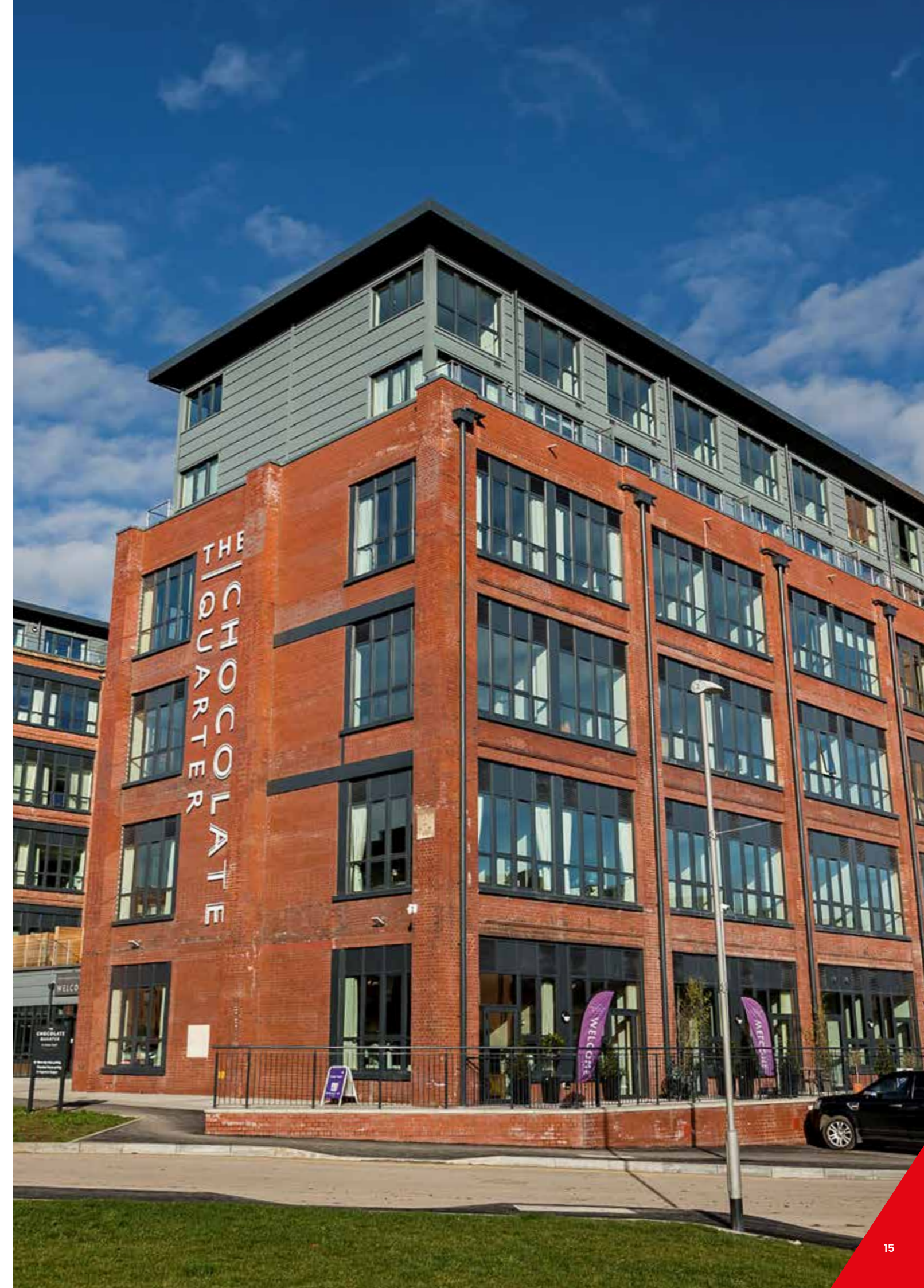



58BW Flush

The 58BW Flush window combines minimal sightlines and maximum weather resistance with all the best features of the tried and trusted 58BW range: advanced performance, versatility and security.

With a choice of slim sashes and a range of configuration options, the flush finish and slim sightlines of the 58BW Flush make this the perfect choice for contemporary new-build and refurbishment projects.

A double rebate provides market-leading weather performance, even in more exposed locations, and the 58BW Flush utilises common hardware with the existing 58BW and Heritage ST window ranges to ensure it can withstand a range of weather conditions.

The 58BW Flush shares the same sashes, features and hardware with the 70mm frame option for the 58BW suite, making it quicker and easier to fabricate with just three new profiles.

DESIGN FEATURES

- › Advanced weather performance – features like the double rebate, and friction stays on side-hung windows offer protection against bad weather conditions
- › Slimmer sightlines – 45mm ultra-slim sash suits a range of property styles
- › Unique polyamide thermal break design to improve thermal performance
- › Certified under the Secured by Design scheme
- › Tested to PAS 24

OPTIONS

- › Open-out sashes including top and side-hung.
- › The flush shadow line can be complimented with a choice of flat, putty line or stepped edge (crittal style) vent styles to suit the property
- › Available in a range of standard and RAL colours.
- › Stock offer – profiles readily available on a 5-day lead time in colours 9910HG, 7016M, and 9005M as well as dual colour white/grey and white/black.

SPECIFICATIONS

PERFORMANCE AND ACCREDITATIONS	
U-Value (Double Glazing) (Ug: 1.0 W/m ² K)	1.5 W/m ² K
Window Energy Rating (WER)	B-C
Air Permeability	Class 4 (600 Pa)
Water Tightness	Class 9a (600 Pa)
Wind Resistance	Class E2400 (2400 Pa)
Acoustic Performance	Rw (C;Ctr) 42 (-1;-5) dB
Security	PAS 24 & SBD
3rd Party Certification Q-Mark	✓
SYSTEM	
Depth	70mm
CONFIGURATIONS	
Top Hung	✓
Side Hung	✓
Dummy Sashes	✓
Multi-Light	✓
French Casement	✓
Fixed Light	✓
SIZE AND WEIGHT LIMITS	
Top Hung	
Max Size (mm)	1400w x 1200h
Min. Size (mm)	350w x 250h
Max Weight	35kg
Side Hung	
Max Size (mm)	700w x 1400h
Min. Size (mm)	300w x 350h
Max Weight	26kg
Fixed Light	
Max Weight	250kg
GLAZING	
Glazing Options	Internal Bead
Glazing Thickness	24mm – 35mm
SYSTEM FEATURES	
Single Colour	✓
Dual Colour	✓
Textured Finish	✓
Anodised Finish	✓
Multi-Point Locking	✓
Sightline (Frame to Vent)	74mm
Sightline (Vent to Mullion to Vent)	111mm
Sightline (Dummy Sash)	74mm
Sightline (Fixed Light)	43mm

CAD CROSS SECTIONS AND THERMAL PROFILE

Additional details are available on request.

JAMB Sections

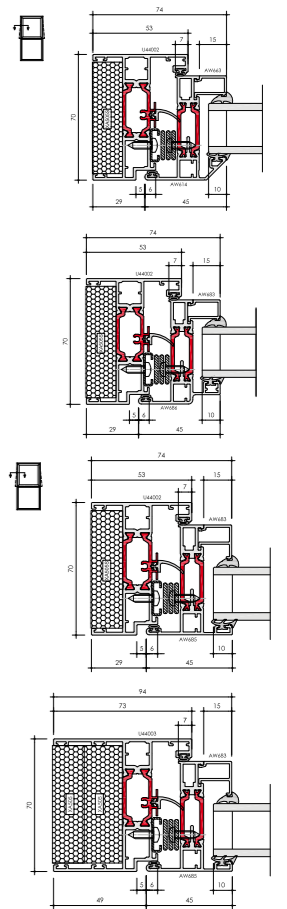

French Casement Floating Mullion

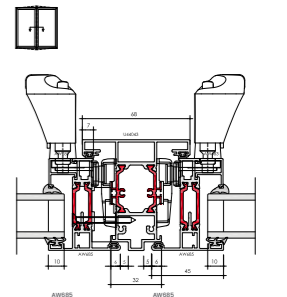

58BW ST Flush

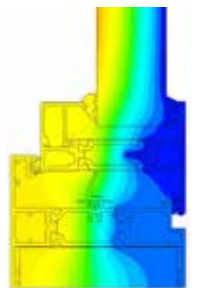

Contemporary Design with a traditional twist

AluK's 58BW Flush windows were launched at the start of 2020 as the ideal replacement for timber windows in traditional refurbishment projects. Replicating the slim sightlines and sharp shadow lines of timber, they offer all the inherent benefits of aluminium, such as low maintenance, and enhanced security, thermal and weather performance.

For the owners of a picturesque brick and flint cottage in rural Hampshire, they proved the perfect choice to replace draughty and inefficient timber frames in their 19th century home.

The owners wanted to replace their existing windows with something which maintained the essential character of the property, but which had a nod to contemporary 21st century design. They chose AluK's 58BW frames, with an ultra slim 45mm sightline on the sash and 24mm on the frame, primarily because of the aesthetics, but also because they are virtually maintenance free.

In total, 13 open out casement windows have been installed in the cottage, all in RAL7004 Signal Grey with a 5mm shadow line and no visible gasket. Double glazed throughout, they are not only eliminating draughts, but also helping to reduce energy bills.

The windows were manufactured by AluK's fabrication partner CWG Choices and installed by Allums Property Services of Newbury. Fabrication is straightforward because the 58BW Flush uses the same standard sash profiles as the AluK 58BW ST window and, installation is made easy thanks to the 70mm depth and internal glazing.

Kevin Allum of Allums Property Services commented: "This was the first time we had installed the 58BW Flush frames and it was a real pleasure. The installation looks great and the homeowners were delighted with the whole process from start to finish."





58BW Casement

Built to the highest UK standards, this effective and high performance solution offers clean lines and advanced functionality.

Available in either 58mm or 70mm frame depth, casement windows are the perfect choice for both residential and light commercial projects, whether new build or renovation. Windows can also be made to project in or out.

DESIGN FEATURES

- › Certified under the Secured By Design scheme
- › Tested to PAS 24
- › Integrated deep head profiles for ease of trickle ventilation
- › Unique polyamide thermal break design to improve thermal performance
- › Casement system sightlines to match the Tilt-Before-Turn window sightlines
- › Reverse rebate option for internal glazing throughout

OPTIONS

- › Available in two frame depths: 58mm or 70mm
- › Supports both open-in and open-out projects
- › Internally or externally glazed to accommodate low and high-rise projects
- › Glazing 23mm-40mm
- › Available in the following configurations: Top Hung, Side Hung, Bottom Hung, Fixed Light, Multi-light and French Casement
- › Available for Lifetime Homes (LFT)
- › Dedicated fixing straps for ease of installation
- › Designed with a Euro Groove to accommodate standard locking hardware
- › Smoke vent certification compliance to EN12101-2:2003 Annex G
- › Available in single or dual colour polyester powder coating, texture and anodised finishes



› Ovolo



› Chamfered



› Square

SPECIFICATIONS

PERFORMANCE* AND ACCREDITATIONS

U-Value (Double Glazing) (Ug: 1.0 W/m²K)	1.4 W/m²K
U-Value (Triple Glazing) (Ug: 0.7 W/m²K)	1.2 W/m²K
Window Energy Rating (WER)	B - C
BRE Green Guide Rating	A Rated
Air Permeability	Class 4 (600 Pa)
Water Tightness	Class 9a (600 Pa)
Wind Resistance	Class E2400 (2400pa)
Acoustic Performance	Rw (C;Ctr) 42 (-1;-5) dB
Security	PAS 24 & SBD
3rd Party Certification Q-Mark	✓

SYSTEM

Depth	58mm & 70mm
-------	-------------

CONFIGURATIONS

Opening	Open-Out
Top Hung	✓
Side Hung	✓
Bottom Hung	✓
Tilt & Turn	x
Fixed Light	✓
Multi-Light	✓
French Casement	✓

SIZE AND WEIGHT LIMITS

Top Hung	
Max Size (mm)	1750w x 2500h
Min. Size (mm)	300w x 200h
Max Weight	180kg
Side Hung	
Max Size (mm)	1300w x 1750h
Min. Size (mm)	300w x 300h
Max Weight	55kg
Bottom Hung	
Max Size (mm)	1750w x 2500h
Min. Size (mm)	300w x 200h
Max Weight	50kg (2 hinges)
Fixed Light	
Max Weight	250kg

GLAZING

Glazing Options	Internal & External Bead
Glazing Thickness	23mm-40mm

SYSTEM FEATURES

Single Colour	✓
Dual Colour	✓
Textured Finish	✓
Anodised Finish	✓
Multi-Point Locking	✓
Smoke Vent Compliance	✓
Sightline (Frame to Vent)	75mm
Sightline (Vent to Mullion)	89mm
Sightline (Fixed Light)	43mm

* Performance data based on CEN size for Building Regulations. For full test performance details please contact Technical Services. AluK recommends checking all system performance for any scheme prior to use.

CAD CROSS SECTIONS AND THERMAL PROFILE

Additional details are available on request.

58BW Mullion Transom

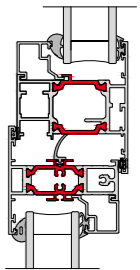

58BW Head

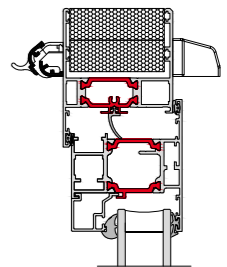

58BW Cill

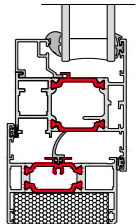

58BW Thermal Profile

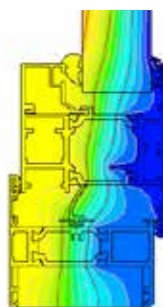



58BW ST Heritage

The look of steel, the benefits of aluminium.
A win-win for designers and homeowners alike.

Featuring industry-leading build quality, our 58BW ST aluminium windows are an ideal replacement for existing steel windows.

In addition to impressive high thermal and acoustic performance, the design also replicates the minimal sightlines associated with steel windows, whilst providing superior performance and security.

DESIGN FEATURES

- › Certified under the Secured By Design scheme
- › Tested to PAS 24
- › Green guide rated A
- › Integrated deep head profiles for ease of trickle ventilation
- › Unique polyamide thermal break design to improve thermal performance
- › Slim sightlines to match existing steel window
- › Internally beaded for ease of glazing on highrise projects

OPTIONS

- › 58mm or 70mm frame depth to accommodate varying types of applications
- › Internally or externally glazed
- › Glazing 25mm – 28mm
- › Available for Lifetime Homes (LFT)
- › Available in a range of single or dual colour and anodised finishes
- › Available in the following aesthetics: Stepped Edge, Square and Putty Line
- › Available in the following configurations: top hung, side hung, bottom hung, fixed light, multi-light and French casement
- › Double headed option allows for internal glazing without the use of dummy vents
- › Accommodates standard hardware



› Square



› Putty Line



› Stepped Edge

SPECIFICATIONS

PERFORMANCE* AND ACCREDITATIONS

U-Value (Double Glazing) (Ug: 1.0 W/m²K)	1.4 W/m²K
U-Value (Triple Glazing) (Ug: 0.7 W/m²K)	1.2 W/m²K
Window Energy Rating (WER)	A - B
BRE Green Guide Rating	A rated
Air Permeability	Class 4 (600 Pa)
Water Tightness	Class 9a (600 Pa)
Wind Resistance	Class E2400 (2400 Pa)
Acoustic Performance	Rw (C;Ctr) 43 (-2;-5) dB
Security	PAS 24 & SBD
3rd Party Certification Q-Mark	✓

SYSTEM

Depth	58mm & 70mm
-------	-------------

CONFIGURATIONS

Opening	Open-Out
Top Hung	✓
Side Hung	✓
Bottom Hung	✓
Fixed Light	✓
Multi-Light	✓

SIZE AND WEIGHT LIMITS

Top Hung	
Max Size (mm)	1400w x 1200h
Min. Size (mm)	350w x 250h
Max Weight	35kg
Side Hung	
Max Size (mm)	700w x 1400h
Min. Size (mm)	300w x 350h
Max Weight	26kg
Bottom Hung	
Max Size (mm)	-
Min. Size (mm)	-
Max Weight	50kg (2 hinges)
Fixed Light	
Max Size (mm)	-
Min. Size (mm)	-
Max Weight	250kg

GLAZING

Glazing Options	Internal & external
Glazing Thickness**	25mm-28mm

SYSTEM FEATURES

Single Colour	✓
Dual Colour	✓
Textured Finish	✓
Anodised Finish	✓
Multi-Point Locking	✓
Sightline (Frame To Vent)	66mm
Sightline (Vent To Mullion)	79mm
Sightline (Fixed Light)	43mm

* Performance data based on CEN size for Building Regulations. For full test performance details please contact Technical Services. AluK recommends checking all system performance for any scheme prior to use.

**Glazing thickness: Other thicknesses may be possible dependant on profile combinations specified. Fabricators should refer to AluK technical manual glazing section for details.

CAD CROSS SECTIONS AND THERMAL PROFILE

Additional details are available on request.

58BW ST Flat

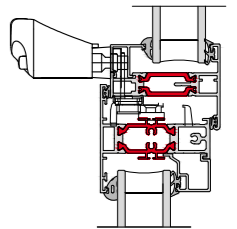

58BW ST Jamb

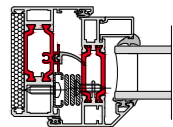

58BW ST Head

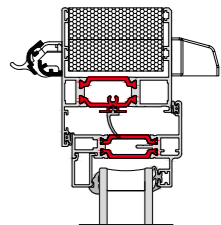

58BW ST Thermal Profile

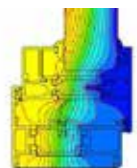

Anything but run of the mill

Grade II listed, Harby Mill on the borders of Nottinghamshire and Lincolnshire was a working tower windmill right up until the 1930s.

An iconic local landmark, it was built in 1877 to replace a wooden original. Once milling on the site ended though, the building lost its sails and gradually fell into a state of disrepair. That was until it was rescued 30 years ago and converted into a quirky and luxurious five-storey home.

The most recent additions are AluK 58BW Heritage aluminium windows and 58BD doors, which have been installed throughout.

The 58BW ST Heritage windows were judged to be a better match to the cast iron originals in the mill tower than the soft wood products which were being replaced, and they were accepted and approved by both the local conservation officer and the planning committee after a detailed reporting process.

Designed primarily to replace steel windows, the 58BW ST profiles feature traditional square sections and sightlines of just 43mm in a fixed light. At Harby Mill, they were specified in RAL1015 Light Ivory finish and, for the 11 windows installed in the tower itself, with matching square glazing bars.

All of the windows and doors feature 24mm double glazing which has transformed the energy efficiency of the property, as well as providing reassuring levels of security over the timber windows they replaced.

AluK's 58BW window system allows fabricators to manufacture a wide range of traditional and contemporary window designs and configurations using a core range of profiles and ancillaries. This makes it a hugely versatile and cost-effective option for specifiers and consumers.





58BW Tilt Before Turn

Offering exceptional child safety and seamless operation, our tilt before turn windows are an ever-popular choice for both multi-residential and light commercial applications.

Made from high performance aluminium these sustainable systems are inherently strong and lightweight. They're also an ideal solution for high-rise buildings where internal glazing and ease of cleaning are essential.



DESIGN FEATURES

- Certified under the Secured By Design scheme
- Tested to PAS 24
- Green guide rated A
- Integrated deep head profiles for ease of trickle ventilation
- Unique polyamide thermal break design to improve thermal performance

OPTIONS

- Glazing 24mm – 40mm
- Available in a range of single or dual colour and anodised finishes
- Available in the following aesthetics: Bay, Contemporary and Square
- Available in the following configurations: tilt-before-turn, side hung, fixed light and multi-light
- Available for Lifetime Homes (LFT)

SPECIFICATIONS

PERFORMANCE* AND ACCREDITATIONS

U-Value (Double Glazing) (Ug: 1.0 W/m²K)	1.5 W/m²K
U-Value (Triple Glazing) (Ug: 0.7 W/m²K)	1.3 W/m²K
Window Energy Rating (WER)	B - C
BRE Green Guide Rating	A Rated
Air Tightness	Class 4 (600 Pa)
Water Tightness	Class 8a (450 Pa)
Wind Resistance	Class E2400 (2400 Pa)
Acoustic Performance	Rw (C;Ctr) 44 (-1;-4) dB
Security	PAS 24 & SBD
3rd Party Certification Q-Mark	✓

SYSTEM

Depth	58mm & 70mm
-------	-------------

CONFIGURATIONS

Opening	Open-In
Top Hung	x
Side Hung	✓
Bottom Hung	✓
Tilt & Turn	✓
Fixed Light	✓
Multi-Light	✓
French Casement	x

SIZE AND WEIGHT LIMITS

Side Hung	
Max Size (mm)	1725w x 2300h
Min. Size (mm)	380w x 575h / 480w x 375h
Max Weight	150kg
Bottom Hung	
Max Size (mm)	1725w x 2300h
Min. Size (mm)	380w x 575h / 480w x 375h
Max Weight	150kg
Tilt & Turn	
Max Size (mm)	1725w x 2300h
Min. Size (mm)	380w x 575h / 480w x 375h
Max Weight	150kg
Fixed Light	
Max Weight	250kg

GLAZING

Glazing Options	Internal Bead
Glazing Thickness	24mm-40mm

SYSTEM FEATURES

Single Colour	✓
Dual Colour	✓
Textured Finish	✓
Anodised Finish	✓
Multi-Point Locking	✓
Lifetime Homes	✓
Sightline (Frame to Vent)	86mm
Sightline (Vent to Mullion)	100mm
Sightline (Fixed Light)	43mm

CAD CROSS SECTIONS AND THERMAL PROFILE

Additional details are available on request.

58BW Open-In Jamb detail

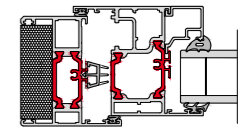

58BW Open-In Mullion detail

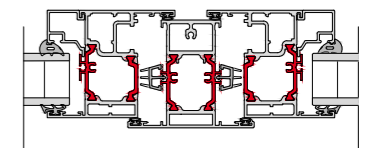

58BW Open-In Transom detail

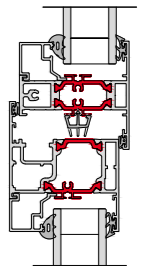

* Performance data based on CEN size for Building Regulations. For full test performance details please contact Technical Services. AluK recommends checking all system performance for any scheme prior to use.

Top Swing Reversible

Easy to clean and effortless to operate, our ever-popular top swing reversible windows increase thermal performance, improve safety and exceed modern building design performance standards.

Ideal for use in high-rise structures, the windows open an impressive 180°, allowing completely pain-free pane cleaning. The system does not encroach inside the building, as the mechanism allows the opening sash to completely rotate on itself whilst remaining outside the building structure.



DESIGN FEATURES

- › Certified under the Secured By Design scheme
- › Tested to PAS 24
- › Green guide rated A
- › Integrated deep head profiles for ease of trickle ventilation
- › Unique polyamide thermal break design to improve thermal performance
- › A clean, flat appearance to give a true contemporary aesthetic
- › Design allows the windows to be pivoted without intruding the internal building line

OPTIONS

- › Glazing 24mm – 28mm
- › Available in a range of single or dual colour and anodised finishes
- › Available in the following aesthetics: Bay, Contemporary and Chamfered
- › Available in the following configurations: top swing, side swing, fixed light and multi-light
- › Dedicated fixing straps for ease of installation
- › Full range of customisable hardware available

SPECIFICATIONS

PERFORMANCE* AND ACCREDITATIONS

U-Value (Double Glazing) (Ug: 1.0 W/m²K)	1.7 W/m²K
BRE Green Guide Rating	A Rated
Air Permeability	Class 4 (600 Pa)
Water Tightness	Class 6a (250 Pa)
Wind Resistance	Class A5 (2000 Pa)
Security	PAS 24 & SBD
3rd Party Certification Q-Mark	✓

SYSTEM

Depth	70mm
-------	------

CONFIGURATIONS

Opening	Open-Out
Top Swing	✓
Side Swing	✓
Fixed Light	✓
Multi-Light	✓

SIZE AND WEIGHT LIMITS

Top Swing	
Max Size (mm)	1400w x 1400h
Min. Size (mm)	300w x 504h
Max Weight	60kg
Fixed Light	
Max Weight	250kg

GLAZING

Glazing Options	Internal
Glazing Thickness	24mm-28mm

SYSTEM FEATURES

Single Colour	✓
Dual Colour	✓
Textured Finish	✓
Anodised Finish	✓
Multi-Point Locking	✓
Sightline (Frame To Vent)	103mm
Sightline (Vent To Mullion)	161mm

CONFIGURATIONS

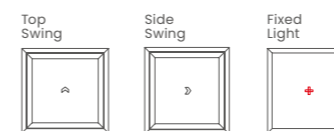

CAD CROSS SECTIONS AND THERMAL PROFILE

Additional details are available on request.

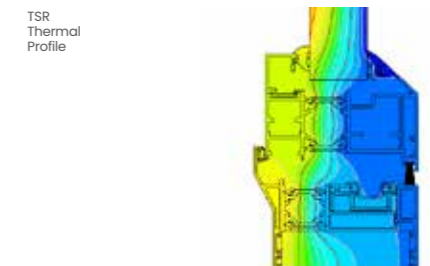
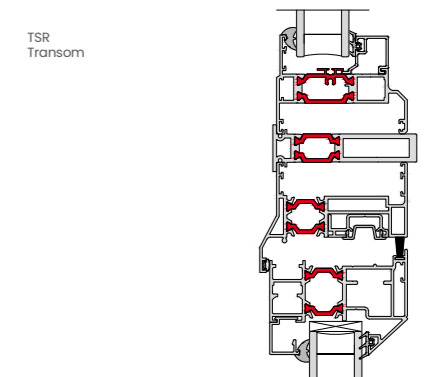
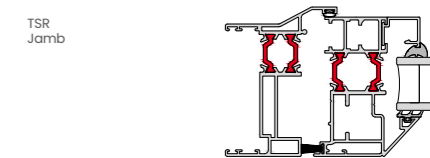
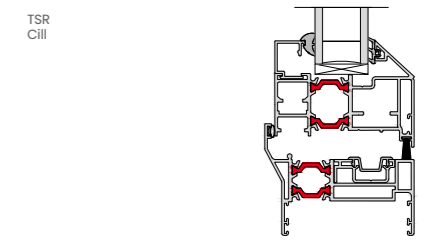
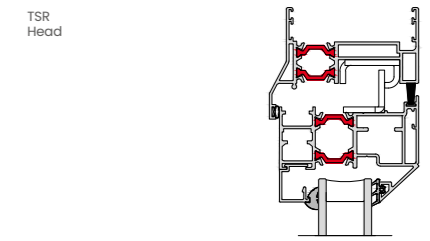

* Performance data based on CEN size for Building Regulations. For full test performance details please contact Technical Services. AluK recommends checking all system performance for any scheme prior to use.



C70S Commercial

Beautifully engineered and brilliantly functional, the C70S delivers class-leading performance with U-values of 1.3 W/m²K, advanced water tightness and a range of features to simplify fabrication and installation.

Meeting and exceeding the key thermal, acoustic and performance demands of the commercial specifiers, the C70S is the perfect aluminium solution for residential and commercial projects.

DESIGN FEATURES

- › Universal EPDM carrier groove – allows clip-in EPDM strip and direct lug fixing to be used on all outer frames, frame extenders and sub sill profiles
- › Outer Frames, Transoms/Mullions, Beads, Gaskets, Ancillary profile parts used across both Open-in and Open-out
- › Consistent sightlines with 58BW system offering maximum project flexibility
- › Euro groove (16mm full depth) allowing for a wider choice of hardware
- › 5-day lead time in 9910HG, 7016M, 9005M and key dual colour options

OPTIONS

- › Three levels of insulation: standard, partial and HI
- › Glazing options 24mm-50mm
- › Side Hung, Top Hung, Fixed Light & Tilt Before Turn configurations available
- › Trickle ventilation available

› Open-out Details



› Open-in Details



SPECIFICATIONS

	C70S HI Open-in	C70S HI Open-out
PERFORMANCE AND ACCREDITATIONS		
Uw (Double Glazing)	1.3W/m ² k	1.3W/m ² k
Uw (Triple Glazing)	1.1W/m ² k	1.1W/m ² k
Window Energy Rating	A Rated	A Rated
Air Tightness (Pa)	Class 4 (600Pa)	Class 4 (600Pa)
Water Tightness (Pa)	E900 (900Pa)	E1500 (1500Pa)
Wind Load (Pa)	Class E2400 (2400Pa)	Class E2400 (2400Pa)
Security	PAS 24 & SBD	PAS 24 & SBD

SYSTEM		
Depth	70mm	70mm

CONFIGURATIONS		
Top Hung	-	✓
Side Hung	✓	✓
Tilt before Turn	✓	-
Bottom Hung	✓	✓
Fixed Light - internally glazed (Reversers available)	✓	✓
Fixed Light - externally glazed (Reversers available)	✓	✓

SIZE AND WEIGHT LIMITS		
Top Hung		
Max Size (mm)	1680w x 2500h	1680w x 2500h
Min. Size (mm)	320w x 267h	320w x 267h
Max Weight	180kg	180kg
Side Hung		
Max Size (mm)	1000w x 1680h	1000w x 1680h
Min. Size (mm)	300w x 320h	300w x 320h
Max Weight	55kg	55kg
Tilt & Turn		
Max Size (mm)	1300w x 2300h	1300w x 2300h
Min. Size (mm)	480w x 375h	480w x 375h
Max Weight	130kg	130kg
Fixed Light		
Max Size (mm)	2300w x 2300h	2300w x 2300h
Min. Size (mm)	300w x 300h	300w x 300h
Max Weight	300kg	300kg

GLAZING		
Glazing panel options: double and triple	24mm - 50mm	24mm - 50mm

SYSTEM FEATURES		
Single Colour	✓	✓
Dual Colour	✓	✓
Anodised	✓	✓
Textured	✓	✓
Locking Handles	✓	✓
Friction Hinges	-	✓
Butt Hinges	-	✓
Groove type	PVC Euro 16mm	PVC Euro 16mm
Variable Handle Position	✓	✓
Trickle ventilation	✓	✓
Sightlines	89mm	89mm
Frame to Vent	89mm	89mm
Vent to Mullion	103mm	103mm
Fixed Light	43mm	43mm

CONFIGURATIONS

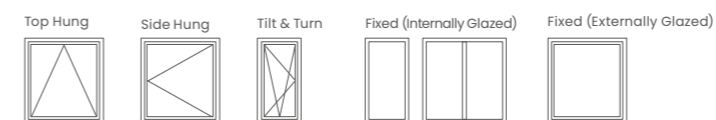

CAD CROSS SECTIONS AND THERMAL PROFILE

Additional details are available on request.

C70S Open-in frame detail

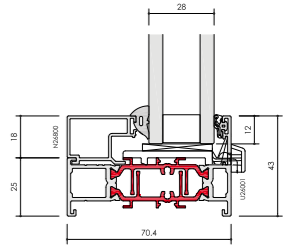

C70S Open-in curtain wall adapter

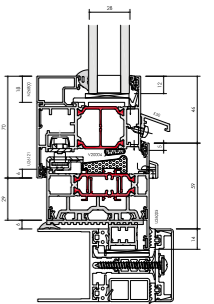

C70S Open-out frame and vent details

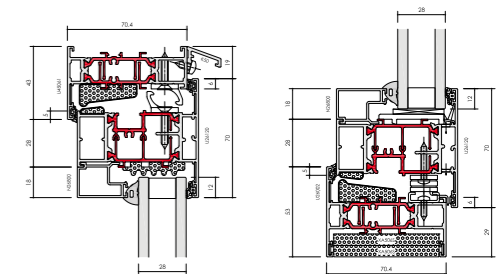

Open-out



Open-in / TBT

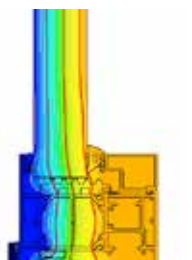

Door systems

Engineered to integrate seamlessly with our window system range, our aluminium door systems remain our most popular products and provide unrivalled safety, security and installation simplicity.

Each door system has its own distinct look and feel, offering varying levels of performance, profile depth and glazing area.

However, while our designs may differ you'll find our materials and manufacturing processes are as reliable as ever. Our fabricating partners can benefit from a 10 year guarantee.

In addition to meeting the needs of every application type, our doors also support the current industry trend for refurbishment over replacement.

This allows fabricators and installers to provide the additional light and space their customers want, in the most fitting way possible.





58BD Entrance

Available in a wide range of styles and formats, our stylish aluminium entrance door system is suitable for both light and medium-duty use.

Designed with security and flexibility front of mind, every door in the range is available in single and double configurations making them ideal for almost any application.

DESIGN FEATURES

- Certified under the Secured By Design scheme
- Tested to PAS 24
- Multi-point locking mechanism
- Designed to incorporate standard and security hardware using the same prep detail
- Cloaking feature conceals lock and prevents any access to locking points

OPTIONS

- Glazing 24mm – 40mm
- 58mm or 70mm frame depth to accommodate varying types of applications
- Low threshold option for Part M – Building regulation
- Available in a range of single or dual colour and anodised finishes
- Available for new build or refurbishment projects
- Available in single or double door configuration



SPECIFICATIONS

	SINGLE OPEN-IN	SINGLE OPEN-OUT	DOUBLE OPEN-IN	DOUBLE OPEN-OUT
PERFORMANCE* AND ACCREDITATIONS				
U-Value (Double Glazing) (Ug: 1.0 W/m²K)	1.7 W/m²K	1.7 W/m²K	1.7 W/m²K	1.7 W/m²K
U-Value (Triple Glazing) (Ug: 0.7 W/m²K)	1.4 W/m²K	1.4 W/m²K	1.5 W/m²K	1.5 W/m²K
Air Permeability	Class 4 (600 Pa)	Class 4 (600 Pa)	Class 2 (300 Pa)	Class 2 (300 Pa)
Water Tightness	Class 3a (100 Pa)	Class 7a (300 Pa)	Class 7a (300 Pa)	Class 9a (600 Pa)
Wind Resistance	Class A3 (1200 Pa)	Class AE2400 (2400 Pa)	Class A2400 (2400 Pa)	Class A2400 (2400 Pa)
Building Regulations Part L Compliant	✓	✓	✓	✓
Building Regulations Part M Compliant	✓	✓	✓	✓
Security	PAS 24 & SBD	PAS 24 & SBD	PAS 24 & SBD	PAS 24 & SBD
Durability EN1191 Category	50,000 Cycles	50,000 Cycles	50,000 Cycles	50,000 Cycles
3rd Party Certification Q-Mark	✓	✓	✓	✓
SYSTEM				
Depth	58mm – 70mm	58mm – 70mm	58mm – 70mm	58mm – 70mm
SIZE AND WEIGHT LIMITS				
Maximum Door Size (mm)	1200w x 2400h	1200w x 2400h	2400w x 2400h	2400w x 2400h
Maximum Door Weight	3 Hinges 67.5kg 4 Hinges 90kg	3 Hinges 67.5kg 4 Hinges 90kg	3 Hinges 67.5kg 4 Hinges 90kg	3 Hinges 67.5kg 4 Hinges 90kg
GLAZING				
Glazing Thickness	24mm-40mm	24mm-40mm	24mm-40mm	24mm-40mm
SYSTEM FEATURES				
Single Colour	✓	✓	✓	✓
Dual Colour	✓	✓	✓	✓
Textured Finish	✓	✓	✓	✓
Anodised Finish	✓	✓	✓	✓
Thermally Broken	✓	✓	✓	✓
Sightline (Head)	129.5mm	129.5mm	129.5mm	129.5mm
Sightline (Cill)	111mm	111mm	111mm	111mm
Sightline (Jamb)	129.5mm	129.5mm	129.5mm	129.5mm
Sightline (Meeting Stile)	n/a	n/a	209.5mm	209.5mm
Panel Door	✓	✓	✓	✓
Multi-Point Locking	✓	✓	✓	✓
Barrel Hinges	✓	✓	✓	✓
Low Threshold	✓	✓	✓	✓
APPLICATIONS				
New Build	✓	✓	✓	✓
Refurbishment	✓	✓	✓	✓

CONFIGURATIONS

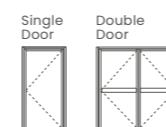

CAD CROSS SECTIONS AND THERMAL PROFILE

Additional details are available on request.

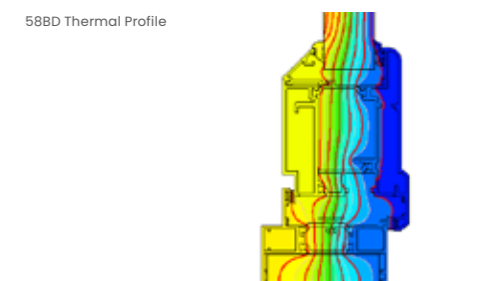
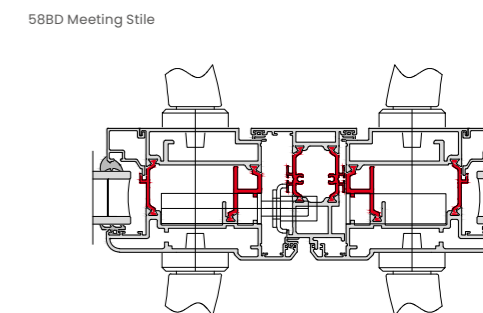
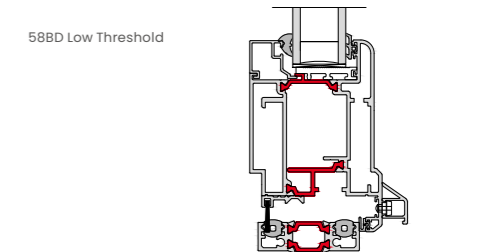
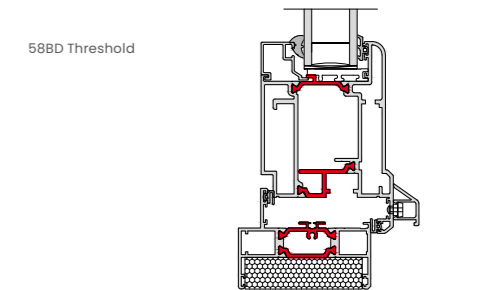
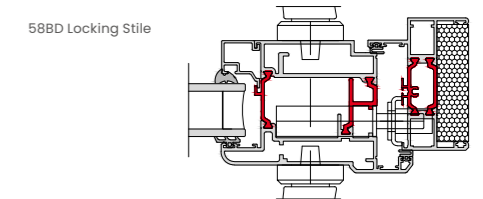
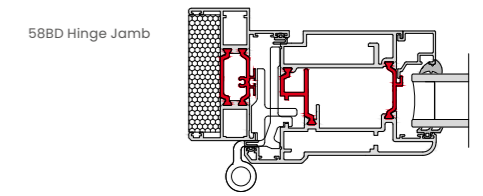

* Performance data based on CEN size for Building Regulations. For full test performance details please contact Technical Services. AluK recommends checking all system performance for any scheme prior to use.



58BD Flush Entrance

Available in a wide range of styles and formats, our stylish aluminium entrance door system is suitable for both light and medium-duty use.

Designed with security and flexibility front of mind, every door in the range is available in single and double configurations making them ideal for almost any application.

DESIGN FEATURES

- Accepts 24mm – 40mm double or triple glazing
- Max vent weight 90kg
- Max Frame Height 2160mm
- Multi-point locking mechanism
- Available in single and dual colour



SPECIFICATIONS

	SINGLE OPEN-IN	SINGLE OPEN-OUT	DOUBLE OPEN-IN	DOUBLE OPEN-OUT
PERFORMANCE* AND ACCREDITATIONS				
U-Value (Double Glazing) (Ug: 1.0 W/m²K)	1.6 W/m²K	1.7 W/m²K	1.7 W/m²K	1.6 W/m²K
U-Value (Triple Glazing) (Ug: 0.7 W/m²K)	1.4 W/m²K	1.4 W/m²K	1.4 W/m²K	1.4 W/m²K
Air Permeability	Class 2 (300 Pa)	Class 2 (300 Pa)	Class 2 (300 Pa)	Class 1 (150 Pa)
Water Tightness	Class 9a (600 Pa)	Class E1950 (1950 Pa)	Class 4a (150 Pa)	Class 7a (300 Pa)
Wind Resistance	Class A3 (1200 Pa)	Class A3 (1200 Pa)	Class 2 (800 Pa)	Class 2 (800 Pa)
Building Regulations Part L Compliant	✓	✓	✓	✓
Security	PAS 24 & SBD	PAS 24 & SBD	PAS 24 & SBD	PAS 24 & SBD
Durability EN1191 category	50,000 Cycles	50,000 Cycles	50,000 Cycles	50,000 Cycles
3rd Party Certification Q-Mark	✓	✓	✓	✓
SYSTEM				
Depth	58mm - 70mm	58mm - 70mm	58mm - 70mm	58mm - 70mm
SIZE AND WEIGHT LIMITS				
Maximum Door Leaf Size (mm)	1200w x 2400h	1200w x 2400h	2400w x 2400h	2400w x 2400h
Maximum Door Leaf Weight	2 Hinges 100kg 3 Hinges 125kg 4 Hinges 150kg	2 Hinges 100kg 3 Hinges 125kg 4 Hinges 150kg	2 Hinges 100kg 3 Hinges 125kg 4 Hinges 150kg	2 Hinges 100kg 3 Hinges 125kg 4 Hinges 150kg
GLAZING				
Glazing Thickness	24mm-40mm	24mm-40mm	24mm-40mm	24mm-40mm
SYSTEM FEATURES				
Single Colour	✓	✓	✓	✓
Dual Colour	✓	✓	✓	✓
Textured Finish	✓	✓	✓	✓
Anodised Finish	✓	✓	✓	✓
Thermally Broken	✓	✓	✓	✓
Sightlines	119mm Max	119mm Max	175mm (Meeting Stile)	175mm (Meeting Stile)
Panel Door	✓	✓	✓	✓
Multi-Point Locking	✓	✓	✓	✓
Barrel Hinges	✓	✓	✓	✓
APPLICATIONS				
New Build	✓	✓	✓	✓
Refurbishment	✓	✓	✓	✓

CONFIGURATIONS

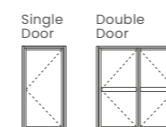

CAD CROSS SECTIONS AND THERMAL PROFILE

Additional details are available on request.

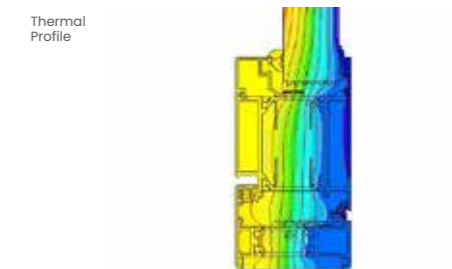
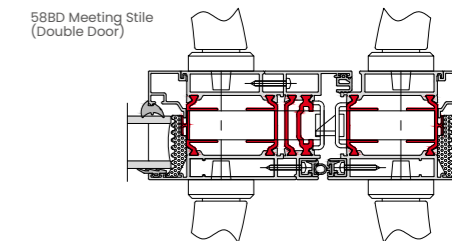
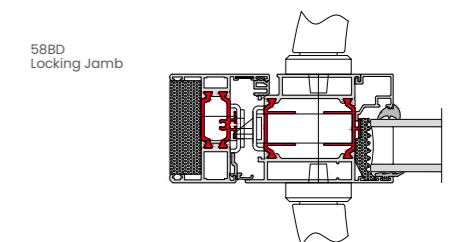
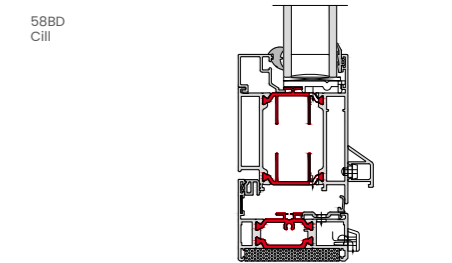
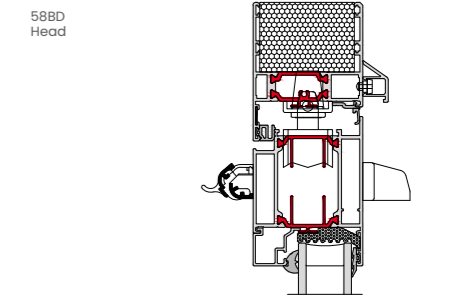
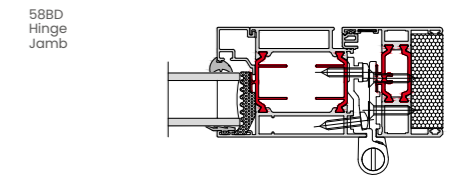

* Performance data based on CEN size for Building Regulations. For full test performance details please contact Technical Services. AluK recommends checking all system performance for any scheme prior to use.



GT55 TB Commercial Door

An effective choice for shop fronts, entrances and ground floor treatments, the GT55 TB provides exceptional security and performance. Delivering high levels of energy efficiency thanks to its thermally broken profiles, the system has been designed in a ladder frame construction to provide a flexible solution for low-rise glazing applications. This means sealed units of 6mm up to 28mm can be accommodated to improve thermal and acoustic performance.

The system offers PAS 24 rating and is Secured By Design-accredited across a suite of configurations including single and double doors, screening, and side and fan lights. It also features a range of PAS 24 hardware including panic, mechanical and electro-mechanical locking for both single and double doors. Easily integrated with other AluK systems, the GT55 TB includes an integrated range of high traffic, anti-finger trap doors suitable for single storey applications.

DESIGN FEATURES

- ▶ Pocket or bead glazed for ease of site glazing
- ▶ 110mm frame depth to accommodate varying types of applications
- ▶ Slim 55mm profile width for increased glazing and light transmission
- ▶ Fully compatible with other AluK systems
- ▶ Mullion drainage options
- ▶ The most comprehensive PAS 24 and Secured By Design certified system on the market today
- ▶ Robust mechanical connection detail between rail and stile for ultimate strength in high traffic environments
- ▶ GT55 TB can be used to create louvred and panelled doors with a variation of inserts

OPTIONS

- ▶ Wide range of hardware available offering full customisation
- ▶ Available in single or dual colour polyester powder coating, texture and anodised finishes
- ▶ Ability to accommodate various architectural pull handles from other manufacturers



SPECIFICATIONS

	SINGLE	DOUBLE	GT55 TB SCREENING
PERFORMANCE AND ACCREDITATIONS			
U-Value (Double Glazing) (Ug: 1.0 W/m²K)	1.9 W/m²K	1.8 W/m²K	1.3 W/m²K
U-Value (Triple Glazing) (Ug: 0.7 W/m²K)	1.7 W/m²K	1.6 W/m²K	1.1 W/m²K
Air Permeability	-	-	Class 4 (600 Pa)
Water Tightness	-	-	Class E1200 (1200 Pa)
Wind Resistance	-	-	Class B4 (1600 Pa)
Durability EN 1191 Category	50,000 Cycles	50,000 Cycles	-
Security	PAS 24 & SBD	PAS 24 & SBD	PAS 24 & SBD
3rd Party Certification Q-Mark	✓	✓	✓
SYSTEM			
Depth	110mm	110mm	110mm
SIZE AND WEIGHT LIMITS			
Maximum Door Leaf Size (mm)	1250w x 2400h	2500w x 2400h	-
Maximum Door Leaf Weight	110kg	110kg	-
GLAZING			
Glazing Thickness (Single Glazing)	-	-	6mm - 12mm
Glazing Thickness (Double Glazing)	24mm - 40mm	24mm - 40mm	24mm - 30mm
SYSTEM FEATURES			
Single Colour	✓	✓	✓
Dual Colour	✓	✓	✓
Textured Finish	✓	✓	✓
Anodised Finish	✓	✓	✓
Thermally Broken	✓	✓	✓
Fire Exit option	✓	✓	✓
Part M compliant low threshold	✓	✓	-
Part M compliant closer	✓	✓	✓
Anti-Finger Trap	✓	✓	-
Sightlines	145mm	176mm	55mm
Mid-Rail and Lay Bar	✓	✓	✓
Panel Door	✓	✓	-
Multi-Point Locking	✓	✓	-
Single Point Locking	✓	✓	-
Concealed Hinges	✓	✓	-
Barrel Hinges	x	x	-
Electro Mechanical Locking	✓	✓	-
APPLICATIONS			
New Build - Residential	✓	✓	✓
New Build - Commercial	✓	✓	✓
Refurbishment	✓	✓	✓
Heavy Commercial	✓	✓	✓

SBD CONFIGURATIONS

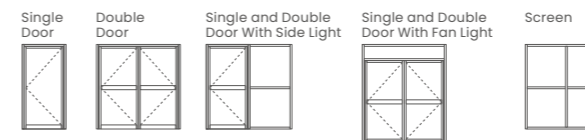

PAS 24 SECURITY RATED LOCK

ALUK PART REF	RELEVANT	SINGLE DOOR				DOUBLE DOOR			
		MIN (W)	MIN (H)	MAX (W)	MAX (H)	MIN (W)	MIN (H)	MAX (W)	MAX (H)
Electronic access locking	1,2,3,4,5	500	-	1200	2400	500	-	1200	2400
Panic Doors (Dorma)	1,2,3,4,5	500	-	1200	2400	500	-	1200	2400
Electronic access panic doors (Dorma)	1,2,3,4,5	500	-	1200	2400	500	-	1200	2400
Panic Doors (Sentinel)	1,3,5	500	1882*	1200	2400	Not available for Double Door			
Manual locking	1,2,3,4,5	500	1882*	1000	2400	500	1882*	1000	2400

CAD CROSS SECTIONS AND THERMAL PROFILE

Additional details are available on request.

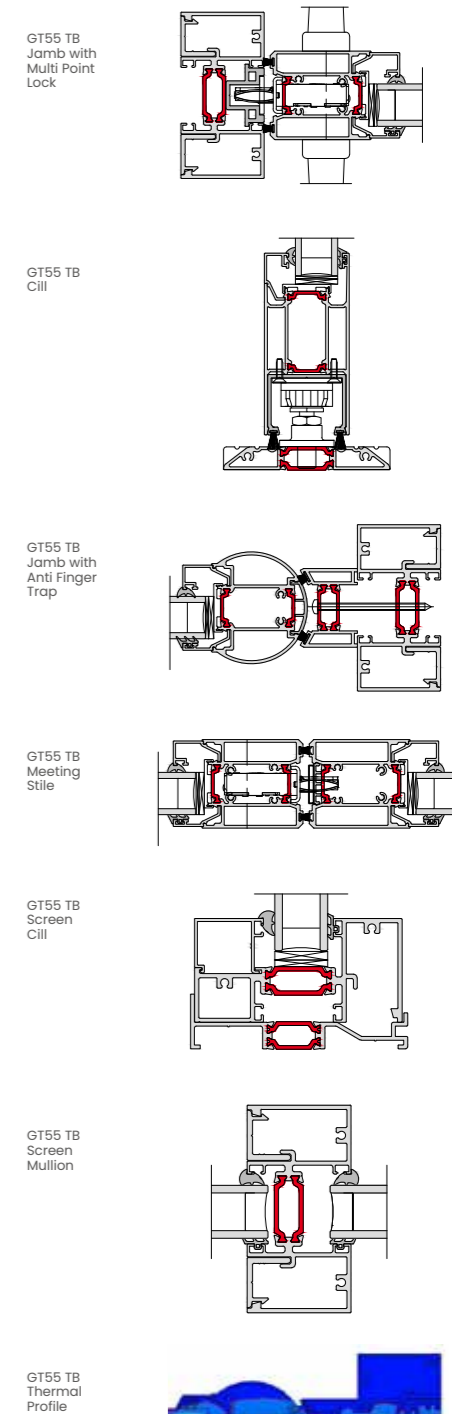



GT55 NI Commercial Door

One of the most secure swing doors available on the market today, the GT55 NI has been specifically designed for high traffic environments where no insulation is required. This makes it a very robust and highly cost-effective choice when specifying applications such as shopping complexes and retail centres that require significant partitioning without the need for thermal insulation.

The GT55 NI can be easily integrated with our ground floor treatment system and is available in single colour options, with a choice of polyester powder coating and anodised finishes. A full range of security and customisable hardware is also available to suit the specific demands of your design.



DESIGN FEATURES

- › Pocket or bead glazed for ease of site glazing
- › 110mm frame depth to accommodate varying types of applications
- › Slim 55mm frame profile for increased glass appearance
- › Ladder frame construction to enable easy on-site installation
- › Fully compatible with other AluK systems
- › Mullion drainage

OPTIONS

- › Can accommodate 6mm–28mm sealed units for acoustic performance
- › Wide range of hardware available offering full customisation
- › Available in single colour polyester powder coating, texture and anodised finishes
- › Internal and external screen application available

SPECIFICATIONS

	SINGLE	DOUBLE	GT55 NI SCREENING
PERFORMANCE AND ACCREDITATIONS			
U-Value (Double Glazing) (Ug: 1.0 W/m²K)	3.6 W/m²K	3.0 W/m²K	2.0 W/m²K
U-Value (Triple Glazing) (Ug: 0.7 W/m²K)	3.4 W/m²K	2.8 W/m²K	1.7 W/m²K
Air Permeability	-	-	Class 4 (600 Pa)
Water Tightness	-	-	Class 8A (450 Pa)
Wind Resistance	-	-	Class 5 (2000 Pa)
Durability EN 1191 Category	50,000 Cycles	50,000 Cycles	-
SYSTEM			
Depth	110mm	110mm	110mm
SIZE AND WEIGHT LIMITS			
Maximum Door Leaf Size (mm)	1250w x 2400h	2500w x 2400h	-
Maximum Door Leaf Weight	80kg	80kg	-
GLAZING			
Glazing Thickness (Single Glazing)	6mm - 12mm	6mm - 12mm	6mm - 12mm
Glazing Thickness (Double Glazing)	24mm - 28mm	24mm - 28mm	24mm - 28mm
SYSTEM FEATURES			
Single Colour	✓	✓	✓
Dual Colour	x	x	x
Textured Finish	✓	✓	✓
Anodised Finish	✓	✓	✓
Fire Exit option	✓	✓	✓
Part M compliant low threshold	✓	✓	-
Anti-Finger Trap	✓	✓	-
Sightlines	144mm	176mm	55mm
Mid-Rail and Lay Bar	✓	✓	✓
Panel Door	✓	✓	-
Single Point Locking	✓	✓	-
Concealed Hinges	✓	✓	-
Barrel Hinges	✓	✓	-
Electro Mechanical Locking	✓	✓	-
Automatic Door	✓	✓	-
APPLICATIONS			
New Build - Residential	✓	x	x
New Build - Commercial	✓	✓	✓
Refurbishment	✓	✓	✓
Heavy Commercial	✓	✓	✓

CAD CROSS SECTIONS AND THERMAL PROFILE

Additional details are available on request.

GT55 NI
Jamb
Locking
Stile

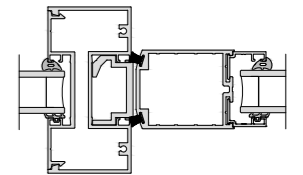

GT55 NI
Meeting
Stile



GT55 NI
Screen
Cill

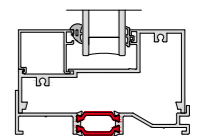

GT55 NI
Screen
Mullion

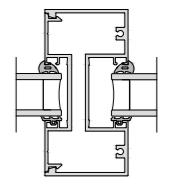

GT55 NI
Jamb
Anti Finger

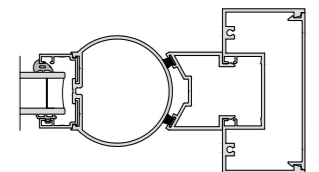

GT55 NI
Door on
Low Threshold

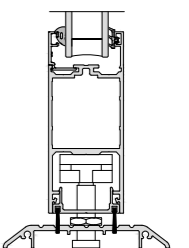

GT55 NI
Thermal Profile

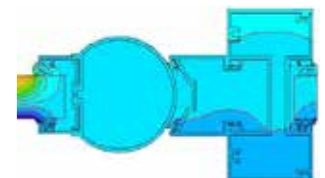



INFINIUM Sliding

Infinium brings together indoor and outdoor living spaces in exquisite harmony.

Free-flowing spaces are created thanks to stunningly slim sightlines that bathe every surface with natural light. Uninterrupted panoramic landscapes provide complete escapism, without need of escape.

While seamlessly integrated floor-to-ceiling glazing reflects the clarity of thought behind every inspired design decision.

DESIGN FEATURES

- Fully concealed outer-frame
- 21mm central interlock
- One or more opening panels with large width dimensions up to 3000mm and height dimensions up to 3500mm
- Holds up to 400 kg panel weight

OPTIONS

- Available in double or triple track
- Glazing options of 38mm – 52mm
- Floating corner post option for larger opening space
- Single colour available as standard
- Available in a range of configurations
- Double or triple glazing solutions available on the same outer-frame



SPECIFICATIONS

PERFORMANCE AND ACCREDITATIONS	
U-Value (Double Glazing)	1.3 W/m²K
U-Value (Triple Glazing)	< 1.0 W/m²K
Air Permeability	Class 4 (600 Pa)
Water Tightness	Class 8A (450 Pa)
Wind Resistance	Class C3 (1200 Pa up to 160 km/h)
Cycle Testing	25,000
SYSTEM DEPTH	
Duo Rail	175mm
Tri Rail	267mm
CONFIGURATIONS	
Opening	Inline Sliding
Dual Rail	✓
Tri Rail	✓
SIZE AND WEIGHT LIMITS	
Max Sash Height	3500mm
Max Sash Width	3000mm
Max Sash Weight	400kg
GLAZING	
Glazing Thickness	38mm-52mm
SYSTEM FEATURES	
Single Colour	✓
Textured Finish	✓
Anodised Finish	✓
Multi-Point Locking	✓
Sightlines - Interlock	21mm

CONFIGURATIONS

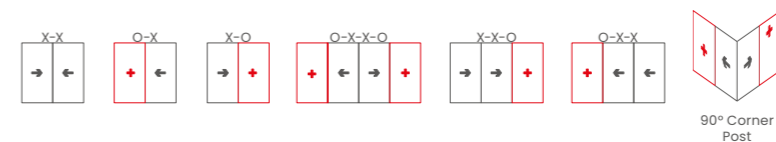

KEY



CAD CROSS SECTIONS AND THERMAL PROFILE

Additional details are available on request.

Infinium Interlock

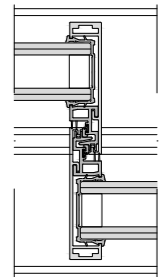

Infinium Jamb Detail

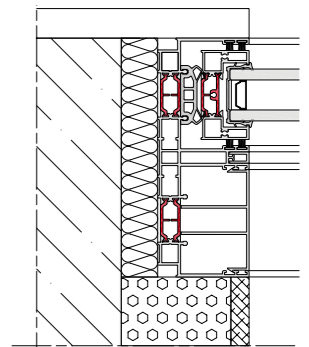

Infinium Cill Detail

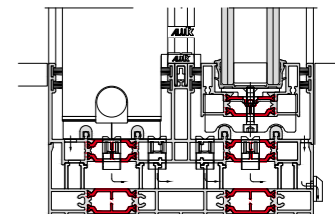

Infinium Thermal Profile

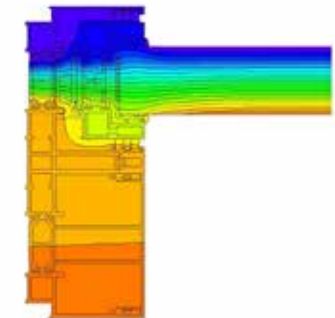

Infinium Thermal Interlock

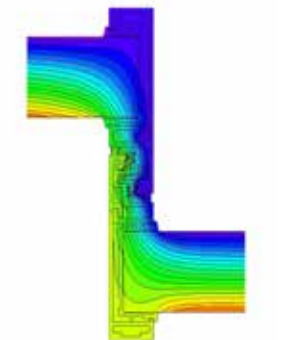



SC156 Lift & Slide

A premium sliding door with slim sightlines, available in a variety of sliding configurations using single and double track systems.

The SC156 offers high levels of performance, from thermal U-values of 1.0W/m²K (triple glazed), to superior water tightness on the market (1500 Pa) and with panel weights of up to 400Kg.

Smooth operation is guaranteed through the use of the highest quality fittings.



DESIGN FEATURES

- Accepts 24mm – 50mm double or triple glazing
- Max 400kg panel weight
- Low threshold of 23mm
- Exceptional AWW ratings

OPTIONS

- Slimmer sightline of 50mm available
- Multiple sliding configurations
- Mono or Dual rail options
- Available in single and dual colour; any other RAL also available
- Range of hardware and security features

SPECIFICATIONS

	SC156	SC156 SLIM
PERFORMANCE* AND ACCREDITATIONS		
U-value (Double Glazing) (Ug = 1.0 W/m ² K) (Mono Rail)	1.4 W/m ² K	1.4 W/m ² K
U-value (Triple Glazing) (Ug = 0.6 W/m ² K) (Mono Rail)	1.0 W/m ² K	1.0 W/m ² K
U-value (Double Glazing) (Ug = 1.0 W/m ² K) (Dual Rail)	1.5 W/m ² K	1.6 W/m ² K
U-value (Triple Glazing) (Ug = 0.6 W/m ² K) (Dual Rail)	1.2 W/m ² K	1.3 W/m ² K
Air Permeability	Class 4 (600 Pa)	Class 4 (600 Pa)
Water Tightness	Class E1500 (1500Pa)	Class E1500 (1500Pa)
Wind Resistance	Class 4 (1600 Pa)	Class 4 (1600 Pa)
Acoustic Performance	Rw(Ct;Ctr) = 44 (-2;-6) dB	Rw(Ct;Ctr) = 44 (-2;-6) dB
Security	PAS 24	PAS 24
SYSTEM		
Depth	156mm	156mm
CONFIGURATIONS		
Opening	Lift & Slide	Lift & Slide
Mono Rail	✓	✓
Dual Rail	✓	✓
SIZE AND WEIGHT LIMITS		
Max Frame Height	3100mm	3100mm
Max Vent Height	3100mm	3100mm
Max Vent Width	2700mm	2700mm
Max Vent Weight*	300kg	300kg
GLAZING		
Glazing Options	Internal	Internal
Glazing Thickness	24mm-50mm	24mm-50mm
SYSTEM FEATURES		
Single Colour	✓	✓
Dual Colour	✓	✓
Textured Finish	✓	✓
Anodised Finish	✓	✓
Multi-Point Locking	✓	✓
Threshold	23mm	23mm
Sightlines	95mm	50mm

* 300kg on standard roller sets, 400kg with additional roller set

CONFIGURATIONS

MONO RAIL



DUAL RAIL



KEY



* Performance data based on CEN size for Building Regulations. For full test performance details please contact Technical Services. AluK recommends checking all system performance for any scheme prior to use.

CAD CROSS SECTIONS AND THERMAL PROFILE

Additional details are available on request.

SC156 Head

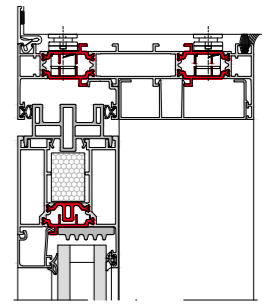

SC156 Interlock

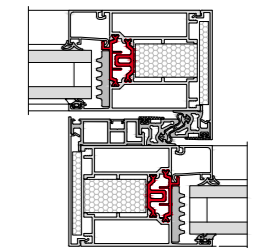

SC156 Interlock Slim

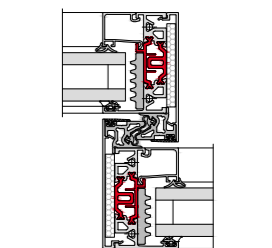

SC156 Cill

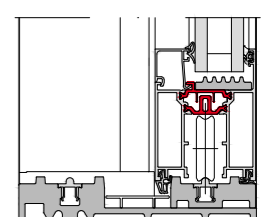

SC156 Jamb

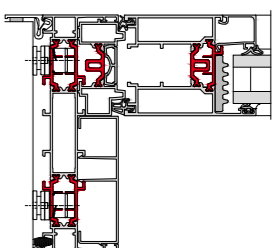

SC156 Thermal Profile

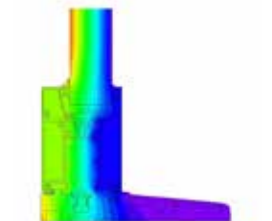



BSC94 Lift & Slide

For those looking for effortless operation, look no further than our premium lift and slide door. Its vital statistics are impossible to ignore.

Thermal U-Values of 1.5W/m²K (triple glazed). Panel weights of up to 400kg. Sightlines as little as 45mm.

The list goes on. As do the benefits, including multiple configurations and a wide choice of colour finishes.

DESIGN FEATURES

- Accepts 20mm – 31mm double glazing
- Max 400kg panel weight (double bogey)

OPTIONS

- Available as Inline Sliding
- Slimmer sightline of 45mm available
- Multiple sliding configurations
- Mono or Dual rail options
- Available in single and dual colour
- Anodised finishes also available
- Range of hardware and security features



SPECIFICATIONS

	BSC94	BSC94 SLIM
PERFORMANCE* AND ACCREDITATIONS		
U-Value (Double Glazing) (Ug = 1.0 W/m ² K) (Mono Rail)	1.7 W/m ² K	x
U-Value (Triple Glazing) (Ug = 0.7 W/m ² K) (Mono Rail)	1.5 W/m ² K	x
U-Value (Double Glazing) (Ug = 1.0 W/m ² K) (Dual Rail)	1.9 W/m ² K	1.9 W/m ² K
U-Value (Triple Glazing) (Ug = 0.7 W/m ² K) (Dual Rail)	1.7 W/m ² K	1.6 W/m ² K
BRE Green Guide Rating	C Rated	C Rated
Air Permeability	Class 4 (600 Pa)	Class 4 (600 Pa)
Water Tightness	Class 7a (300 Pa)	Class 7a (300 Pa)
Wind Resistance	C3 (1200 Pa)	C3 (1200 Pa)
Acoustic Performance	-	-
SYSTEM		
Depth	94mm-155mm	94mm-155mm
CONFIGURATIONS		
Opening	Lift & Slide	Lift & Slide
Mono Rail	✓	x
Dual Rail	✓	✓
Tri Rail	✓	x
SIZE AND WEIGHT LIMITS		
Max Frame Height	3000mm	3000mm
Max Vent Width	2000mm	2000mm
Max Vent Weight	400kg	400kg
GLAZING		
Glazing Options	Internal	Internal
Glazing Thickness	20mm-31mm	20mm-31mm
SYSTEM FEATURES		
Single Colour	✓	✓
Dual Colour	✓	✓
Textured Finish	✓	✓
Anodised Finish	✓	✓
Multi-Point Locking	✓	✓
Sightlines (Interlock)	100mm	45mm
Sightlines (Cill)	130.5mm	130.5mm
Sightlines (Head)	130.5mm	130.5mm
Sightlines (Jamb)	130.5mm	130.5mm

CONFIGURATIONS

MONO RAIL



DUAL RAIL



TRI RAIL



KEY



* Performance data based on CEN size for Building Regulations. For full test performance details please contact Technical Services. AluK recommends checking all system performance for any scheme prior to use.

CAD CROSS SECTIONS AND THERMAL PROFILE

Additional details are available on request.

BSC94 Mono Rail Standard Interlock

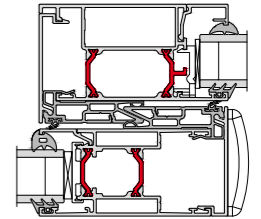

BSC94 Mono Rail Cill

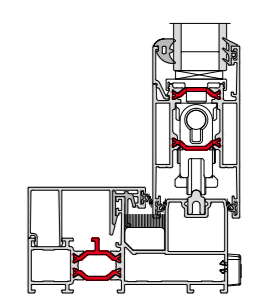

BSC94 Dual Rail Standard Interlock

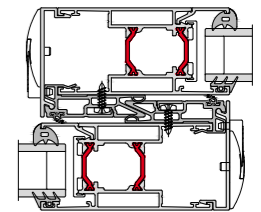

BSC94 Dual Rail Cill

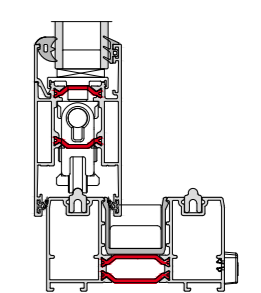

BSC94 Dual Rail/Tri Rail Standard Slimline Interlock

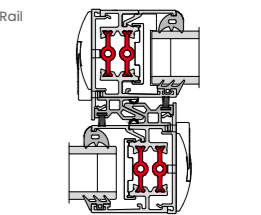

BSC94 Thermal Profile

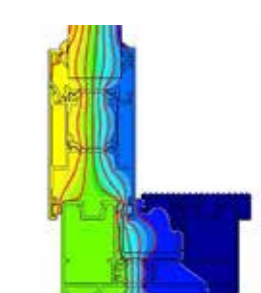



BSC94 In-line Sliding

Combining high performance with stunning design, our sliding aluminium door systems provide a versatile solution for any architectural project.

Manufactured to the highest UK standards, this multi-configuration inline system offers outstanding thermal performance and a wide range of customisable options.

DESIGN FEATURES

- Accepts 20mm – 31mm double glazing
- Max 400kg panel weight
- Certified under the Secured By Design scheme
- Tested to PAS 24
- Anti bi-metal polyamide strip to allow for varying expansion rates

OPTIONS

- Available as Lift & Slide
- Slimmer sightline of 45mm available
- Multiple sliding configurations
- Mono, Dual or Tri rail options
- Available in single and dual colour
- Anodised finishes also available
- Range of hardware and security features



SPECIFICATIONS

	BSC94	BSC94 SLIM
PERFORMANCE* AND ACCREDITATIONS		
U-Value (Double Glazing) (Ug = 1.0 W/m²K) (mono rail)	1.6 W/m²K	x
U-Value (Triple Glazing) (Ug = 0.7 W/m²K) (mono rail)	1.4 W/m²K	x
U-Value (Double Glazing) (Ug = 1.0 W/m²K) (dual Rail)	1.7 W/m²K	1.7 W/m²K
U-Value (Triple Glazing) (Ug = 0.7 W/m²K) (dual Rail)	1.5 W/m²K	1.5 W/m²K
BRE Green Guide Rating	C Rated	C Rated
Air Permeability	Class 4 (600 Pa)	Class 4 (600 Pa)
Water Tightness	Class 7a (300 Pa)	Class 7a (300 Pa)
Wind Resistance	C3 (1200 Pa)	C3 (1200 Pa)
Acoustic Performance	Rw (C;Ctr) 36 (-1;-3) dB**	-
Security	PAS 24 & SBD	x
SYSTEM		
Depth	94mm-155mm	94mm-155mm
CONFIGURATIONS		
Opening	Inline Sliding	Inline Sliding
Mono Rail	✓	x
Dual Rail	✓	✓
Tri Rail	✓	✓
SIZE AND WEIGHT LIMITS		
Max Frame Height	3000mm	3000mm
Max Vent Width	2000mm	2000mm
Max Frame Height With Security Features	2600mm	x
Max Vent Weight	400kg	400kg
GLAZING		
Glazing Options	Internal	Internal
Glazing Thickness	20mm-31mm	20mm-31mm
SYSTEM FEATURES		
Single Colour	✓	✓
Dual Colour	✓	✓
Textured Finish	✓	✓
Anodised Finish	✓	✓
Multi-Point Locking	✓	✓
Sightlines (Interlock)	85mm	45mm
Sightlines (Cill)	115.5mm	115.5mm
Sightlines (Head)	115.5mm	115.5mm
Sightlines (Jamb)	115.5mm	115.5mm

CONFIGURATIONS

MONO RAIL



DUAL RAIL



TRI RAIL



KEY



* Performance data based on CEN size for Building Regulations. For full test performance details please contact Technical Services. AluK recommends checking all system performance for any scheme prior to use.

CAD CROSS SECTIONS AND THERMAL PROFILE

Additional details are available on request.

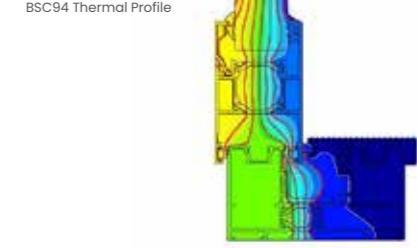
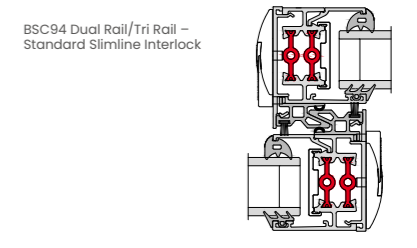
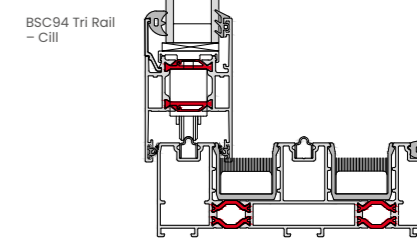
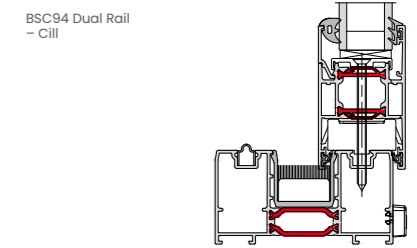
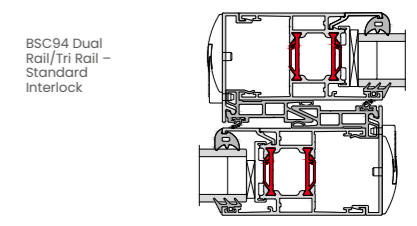
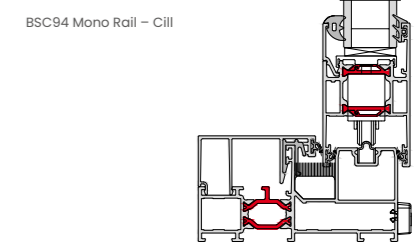
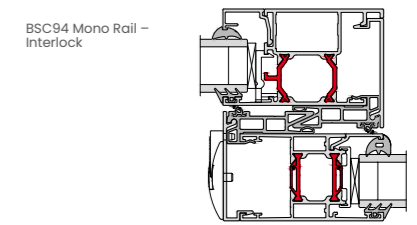



F82 Bi-fold

A contemporary, stylish bi-folding door. With thinner sightlines and interlock of 122mm that provide larger glazing panels without compromising on performance.

It also offers HD compact slim stainless steel rollers as standard allowing for a smoother movement when opening and closing. And with the re-design of the flush pop-out handle form and function perfectly work in harmony.

DESIGN FEATURES

- Re-designed flush pop-out handle
- Unique traffic door
- HD compact rollers as standard
- 4 stainless slim steel rollers
- Both frame and cill sightlines of 97mm
- All configurations available open in and open out

OPTIONS

- Glazing 28mm – 44mm
- Available in a range of opening configurations
- Available in a range of single or dual colour and anodised finishes
- All configurations available open in and open out



SPECIFICATIONS

PERFORMANCE* AND ACCREDITATIONS	
U-Value (Double Glazing) (Ug: 1.0 W/m²K)	1.3 W/m²K
U-Value (Triple Glazing) (Ug: 0.7 W/m²K)	1.0 W/m²K
Air Permeability (Standard Threshold)	Class 3 (600 Pa)
Water Tightness (Standard Threshold)	Class 5a (200 Pa)
Wind Resistance	Class 4A (1600 Pa)
Security	PAS 24 & SBD
SYSTEM	
Depth	82mm
CONFIGURATIONS	
Opening	Open-In & Open-Out
SIZE AND WEIGHT LIMITS	
Max Leaf Height	2600mm
Max Leaf Width	1200mm
Max Vent Weight	150kg
GLAZING	
Glazing Options	Internal Bead
Glazing Thickness	28mm – 44mm
SYSTEM FEATURES	
Single Colour	✓
Dual Colour	✓
Textured Finish	✓
Anodised Finish	✓
Multi-Point Locking	✓
Sightline (Head)	97mm
Sightline (Cill)	97mm
Sightline (Jamb)	97mm
Sightline (Meeting Stile)	122mm

CONFIGURATIONS

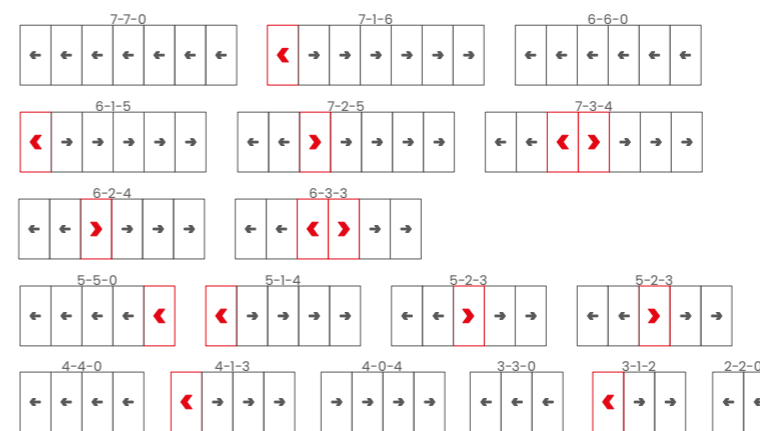

KEY



OTHER OPTIONS AVAILABLE



CAD CROSS SECTIONS AND THERMAL PROFILE

Additional details are available on request.

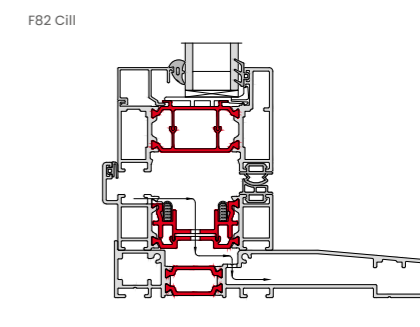
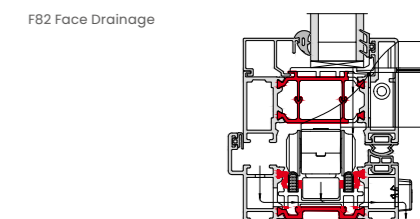
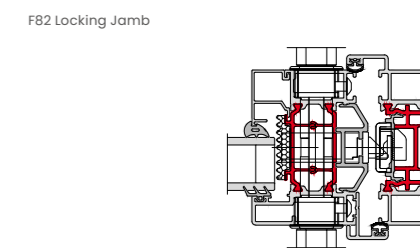
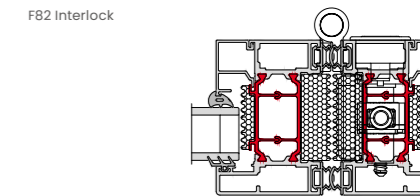
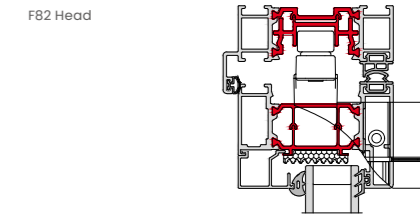

* Performance data based on CEN size for Building Regulations. For full test performance details please contact Technical Services. AluK recommends checking all system performance for any scheme prior to use.



BSF70 Bi-fold

An intelligent combination of form and function, our highly versatile and market-leading Bi-fold sliding door system gives you maximum control over the style and operation of the doors.

Multiple panels can be added to accommodate the design specifications of your building, with the option to open in or out as required.

The system also boasts a unique flush line pop-out handle that allows for square flush stacking panels when doors are fully open.



DESIGN FEATURES

- Certified under the Secured By Design scheme
- Tested to PAS 24
- Unique, pop-out handle that allows for maximum door opening and panels to stack square
- Four stainless steel rollers to ensure smooth and consistent operation

OPTIONS

- Chamfered and square bead options
- Glazing 28mm – 40mm
- Available in a range of opening configurations
- Available with heavy duty rollers; BSF70 HD
- Available in a range of single or dual colour and anodised finishes
- Low threshold 15mm step height
- All configurations available open in and open out
- Chamfered and square based options
- Shootbolts top and bottom of the interlock for enhanced security
- Dedicated bottom bogey guide for consistent operation and enhanced security
- Double track threshold allowing greater stability

SPECIFICATIONS

	BSF70	BSF70 HD
PERFORMANCE* AND ACCREDITATIONS		
U-Value (Double Glazing) (Ug: 1.0 W/m²K)	1.6 W/m²K	1.6 W/m²K
U-Value (Triple Glazing) (Ug: 0.7 W/m²K)	1.4 W/m²K	1.4 W/m²K
Air Permeability (Standard Threshold)	Class 4 (600 Pa)	Class 4 (600 Pa)
Water Tightness (Standard Threshold)	Class 9a (600 Pa)	Class 9a (600 Pa)
Wind Resistance	Class AE2400 (2400 Pa)	Class AE2400 (2400 Pa)
Security	PAS 24 & SBD	PAS 24 & SBD
Cycle Testing	50,000	50,000
3rd Party Certification Q-Mark	✓	✓
SYSTEM		
Depth	70mm	70mm
CONFIGURATIONS		
Opening	Open-In & Open-Out	Open-In & Open-Out
SIZE AND WEIGHT LIMITS		
Max Leaf Height	2400mm	2400mm
Max Leaf Width	1200mm	1200mm
Max Vent Weight	100kg	130kg
GLAZING		
Glazing Options	Internal Bead	Internal Bead
Glazing Thickness	24mm-40mm	24mm-40mm
SYSTEM FEATURES		
Single Colour	✓	✓
Dual Colour	✓	✓
Textured Finish	✓	✓
Anodised Finish	✓	✓
Multi-Point Locking	✓	✓
Sightline (Head)	110mm	110mm
Sightline (Cill)	130mm	130mm
Sightline (Jamb)	110mm	110mm
Sightline (Meeting Stile)	140mm	140mm

CONFIGURATIONS

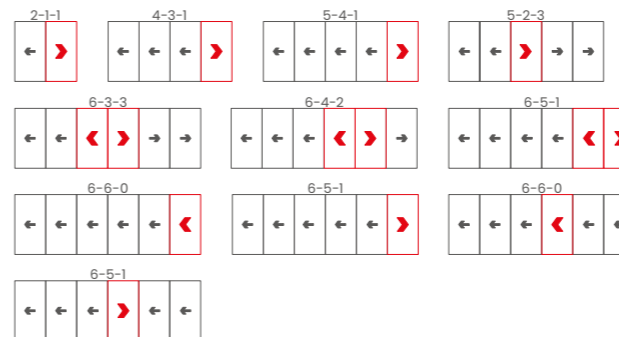

KEY



OTHER OPTIONS AVAILABLE



CAD CROSS SECTIONS AND THERMAL PROFILE

Additional details are available on request.

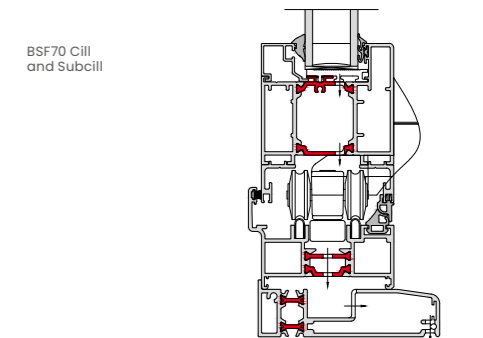
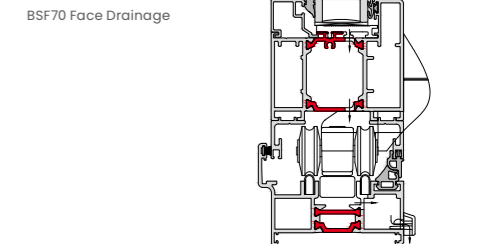
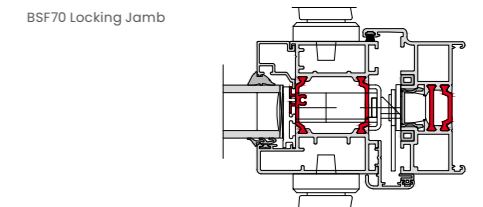
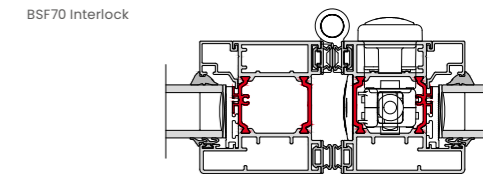
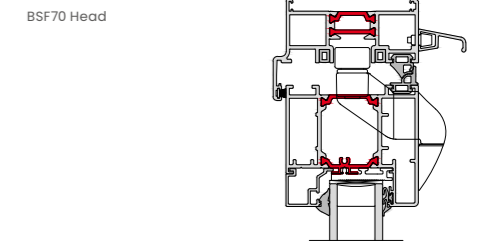

* Performance data based on CEN size for Building Regulations. For full test performance details please contact Technical Services. AluK recommends checking all system performance for any scheme prior to use.

Swimming in compliments

In documenting the contemporary renovation and redevelopment of their 1910 5-bedroom property in South Wales, the owners of @ourgranddesign1 have already attracted more than 17500 followers.

While the whole project is impressive, the most likes on the account so far have been on the images of the stunning garden and pool room, surrounded on two complete sides by AluK's iconic BSF70 bi-folds.

The Californian original, which inspired the design, was open on two sides with a cantilevered roof, but the Welsh owners sensibly opted for bi-folding doors on their version - to cope with the vagaries of the UK weather.

Two five-panel BSF70 bi-folds installed on the front of the garden room open out from the centre, while the pool area features a single, nine-panel bi-fold which opens up one way from right to left to create a seamless link between inside and out. There are also two further five-panel BSF70 bi-folds installed at the end of the building and working as a divider between the two separate zones.

The garden and pool room sits at the end of the property's half acre garden and there is even a three metre AluK 58BW fixed light window installed in the newly extended open plan kitchen to frame the view of it.

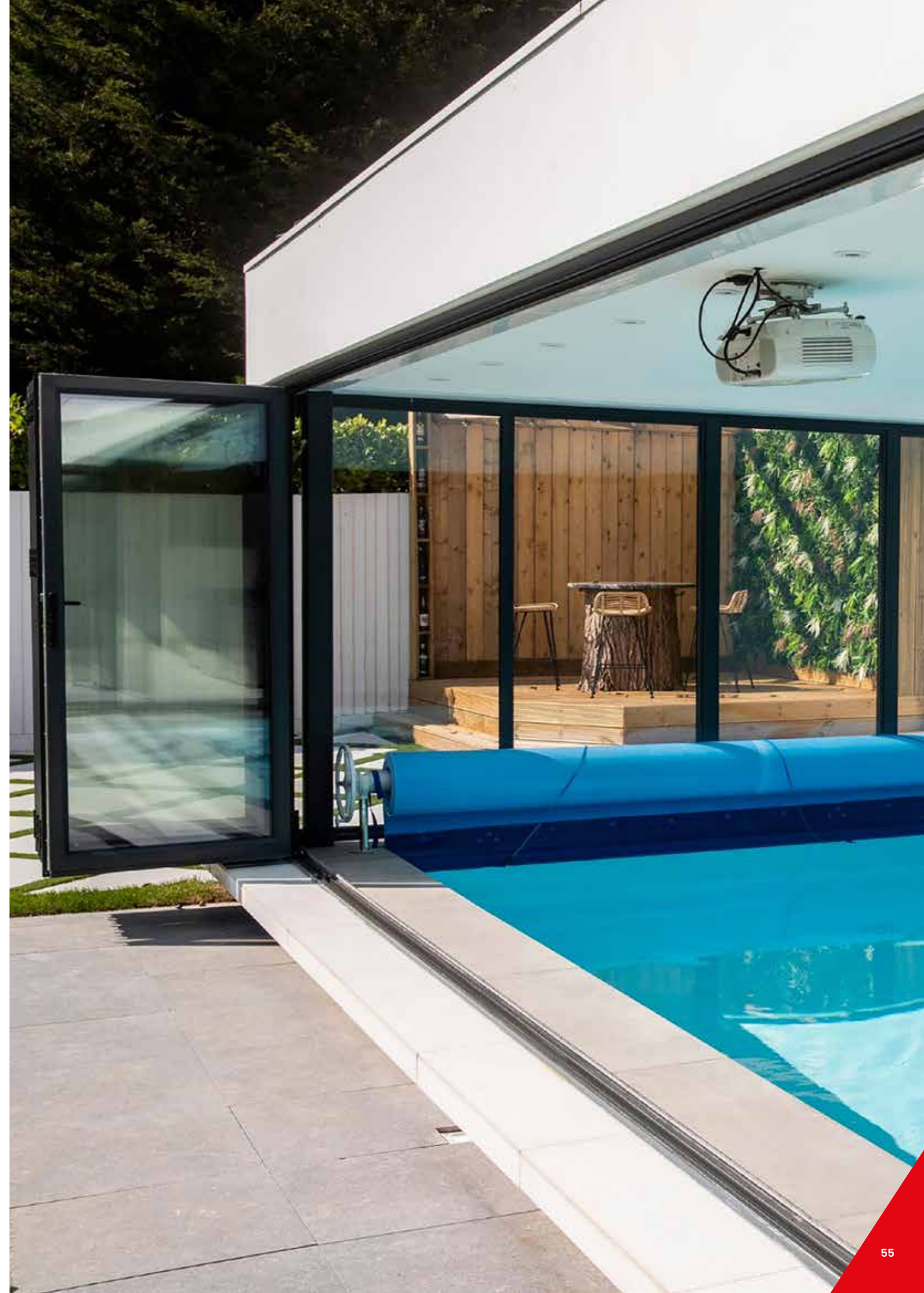

Revolution Trade Frames Ltd

Unit 1 & 2,
Newman Road Industrial
Estate,
Purley Way,
Croydon CR0 3JX
020 8194 6687
office@rtframes.co.uk
www.rtframes.co.uk

T: 01291 639 739

E: info.uk@aluk.com

Registered Office:

AluK (GB) Ltd

Newhouse Farm Ind Est

Chepstow

NP16 6UD

London Office:

AluK Design Studio

5-11 Worship Street

London

EC2A 2BH

Registered Number:

02881320